

1 BALLASTED INVERTER MOUNT – SIDE
S5.0 NTS

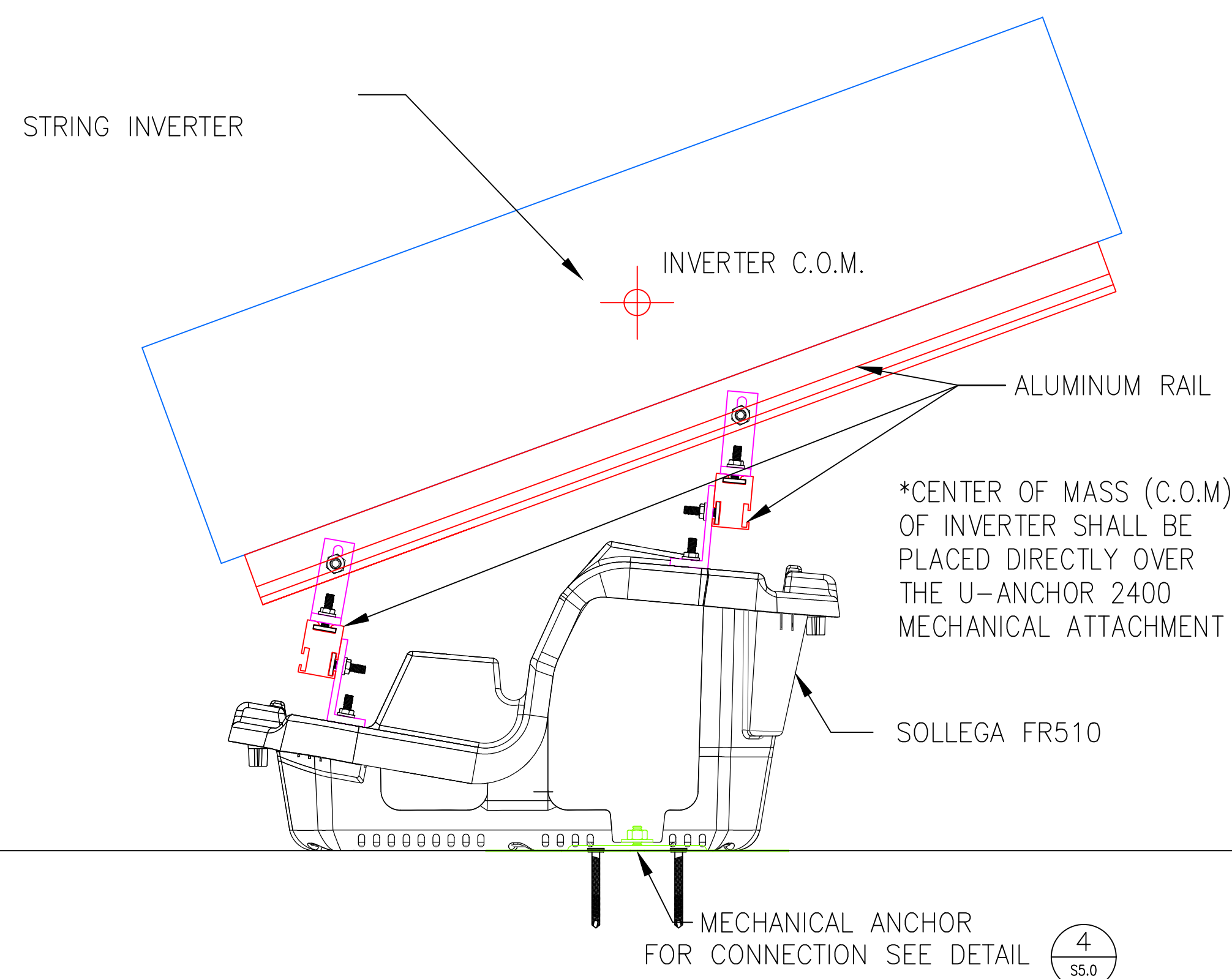

2 RAIL / L-BRACKET CONNECTION
S5.0 NTS

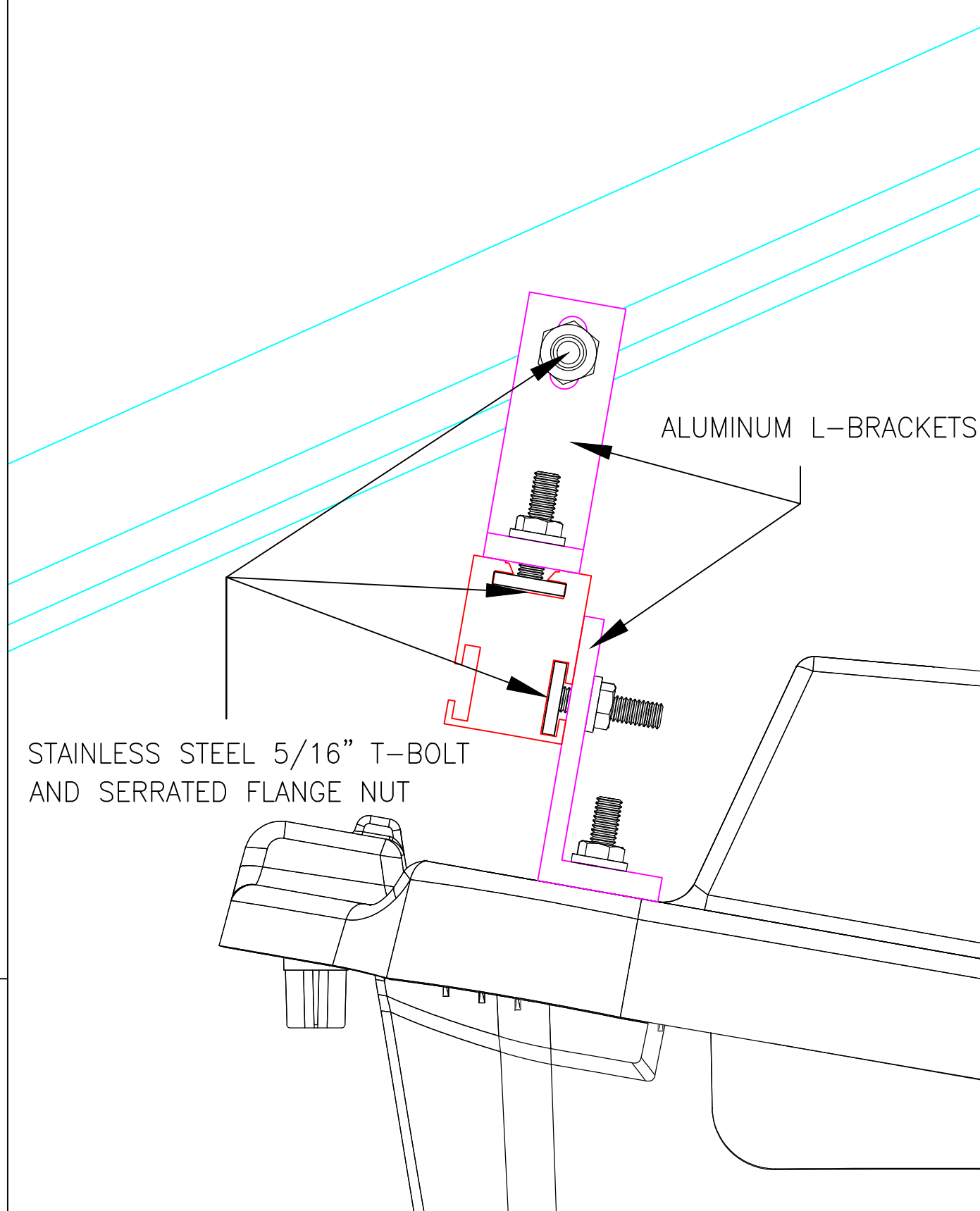

3A FULL 3 INVERTER ASSEMBLY – FRONT
S5.0 NTS

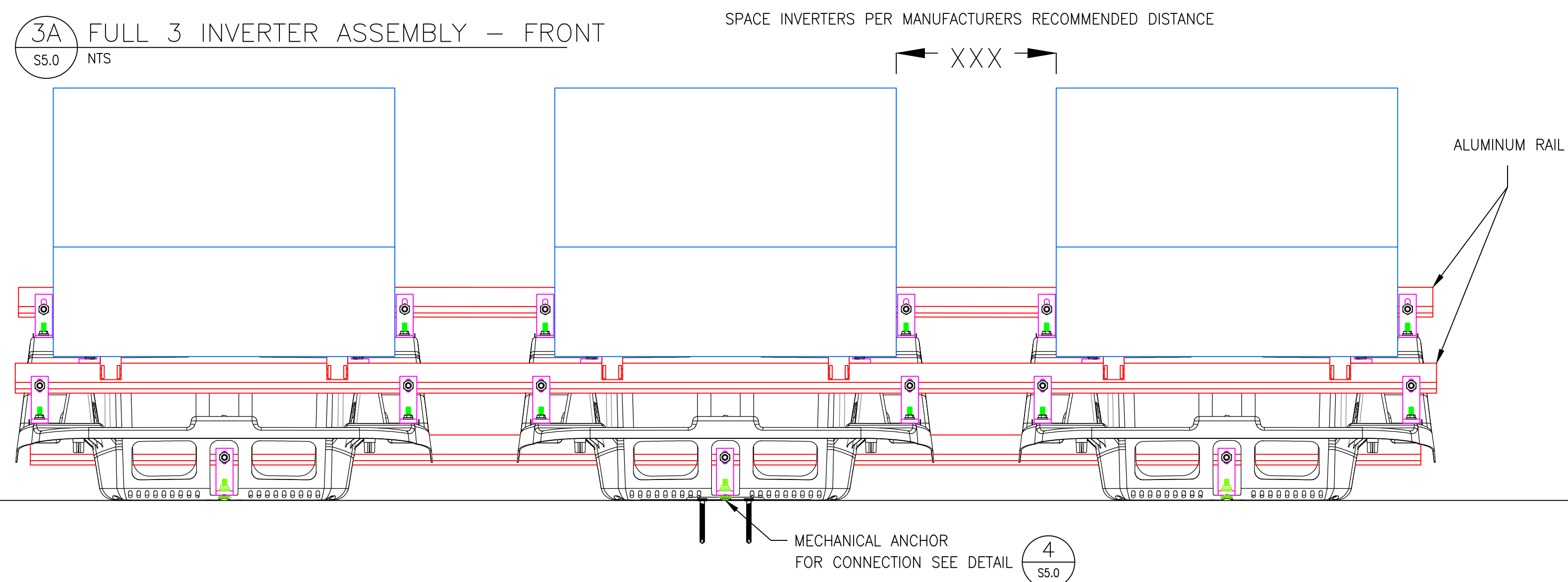

3B FULL 2 INVERTER ASSEMBLY – FRONT
S5.0 NTS

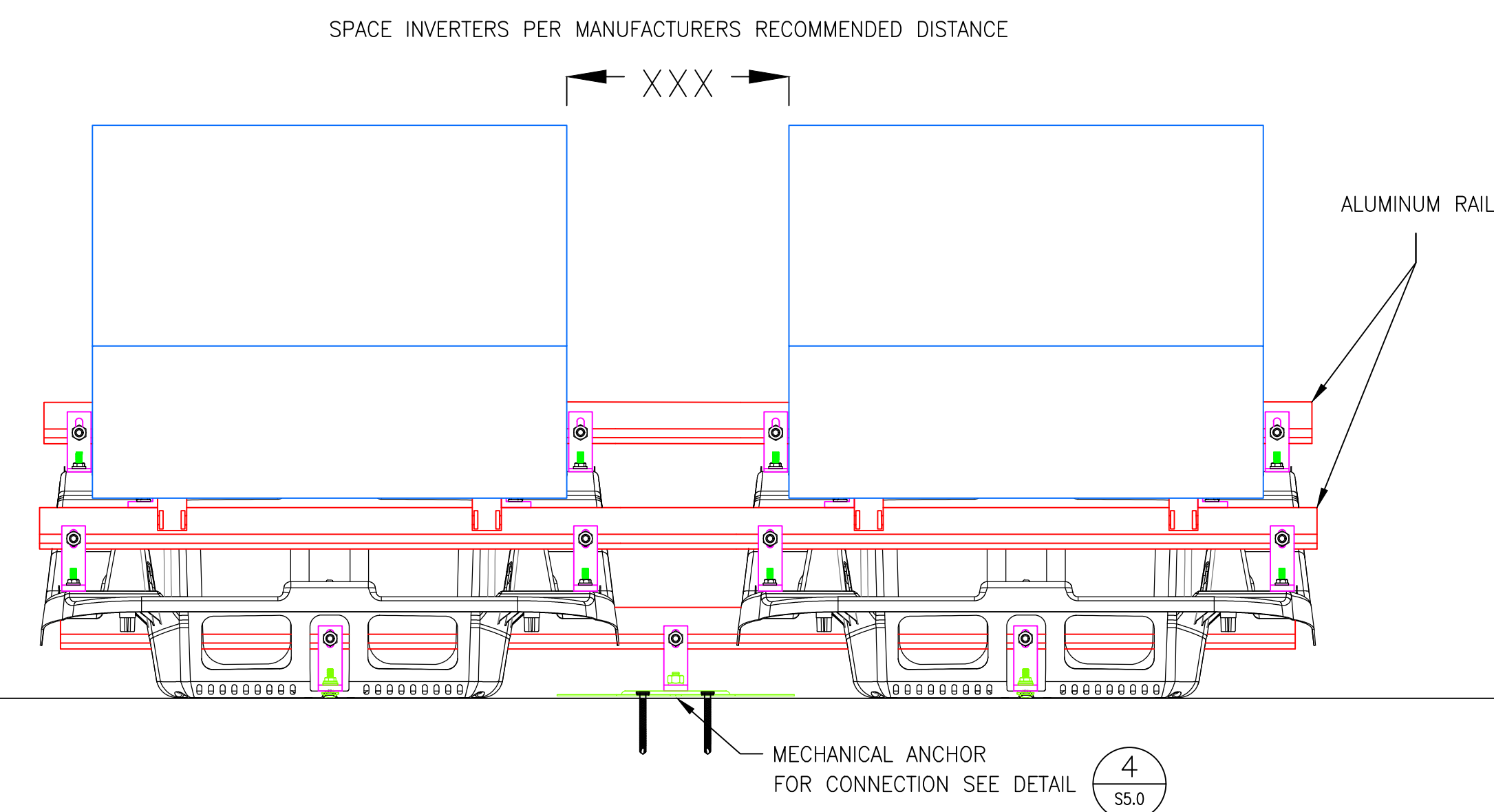

3C FULL SINGLE INVERTER ASSEMBLY – FRONT
S5.0 NTS

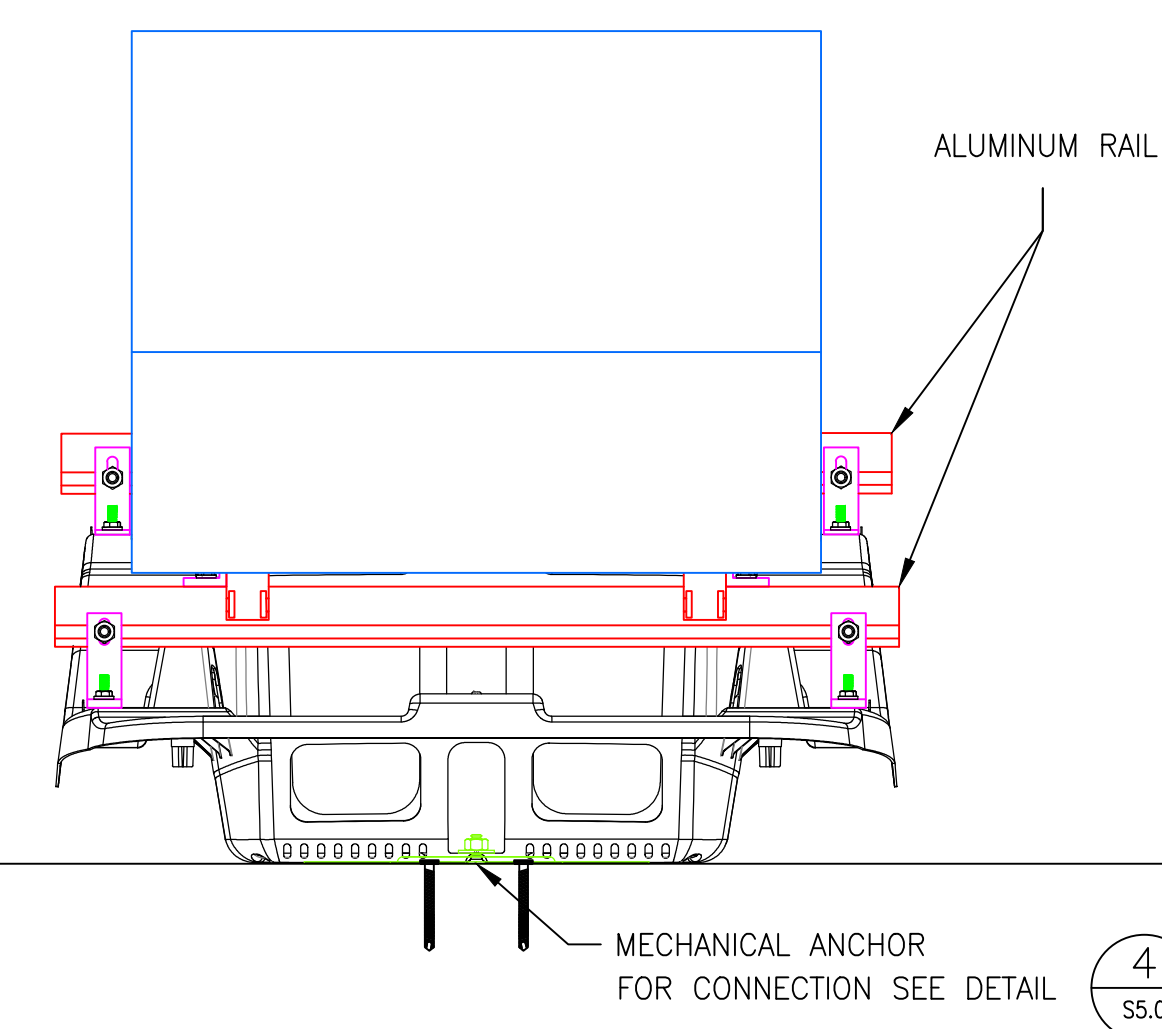

4 ANCHOR / DECK CONNECTION
S5.0 NTS

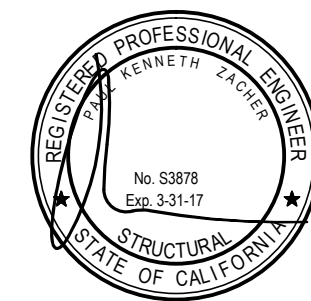
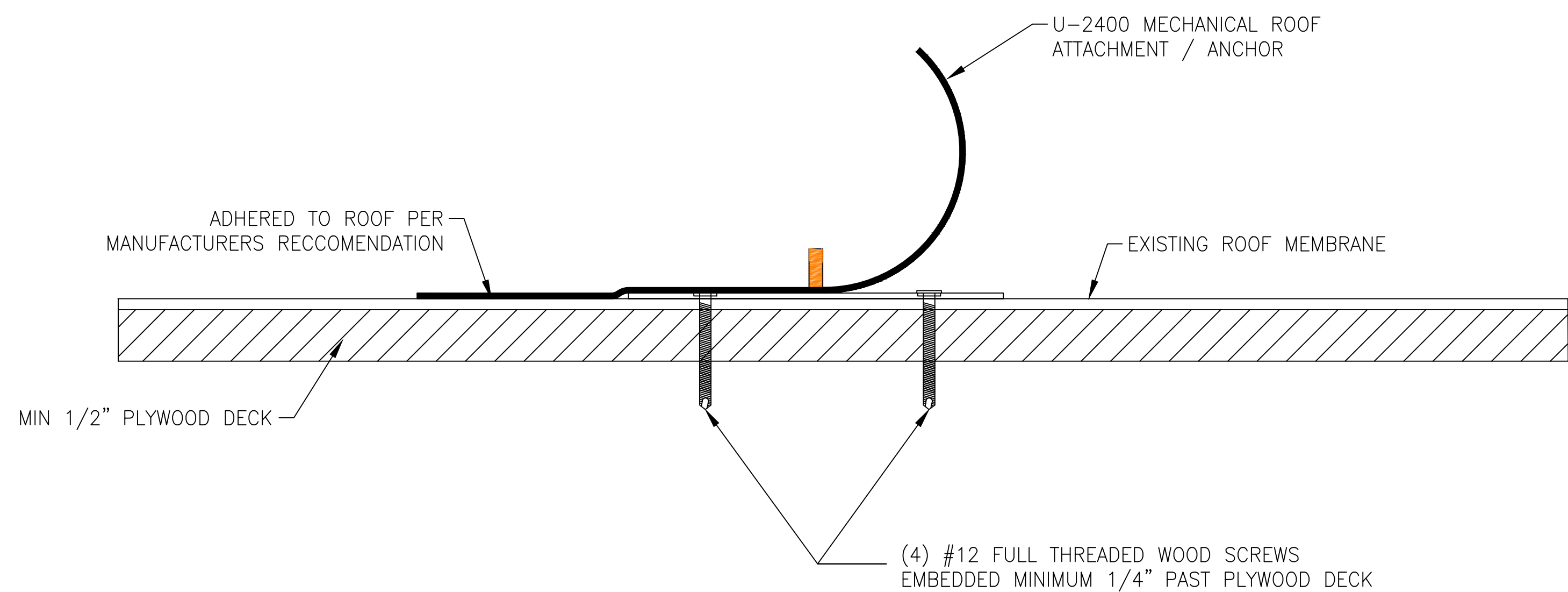
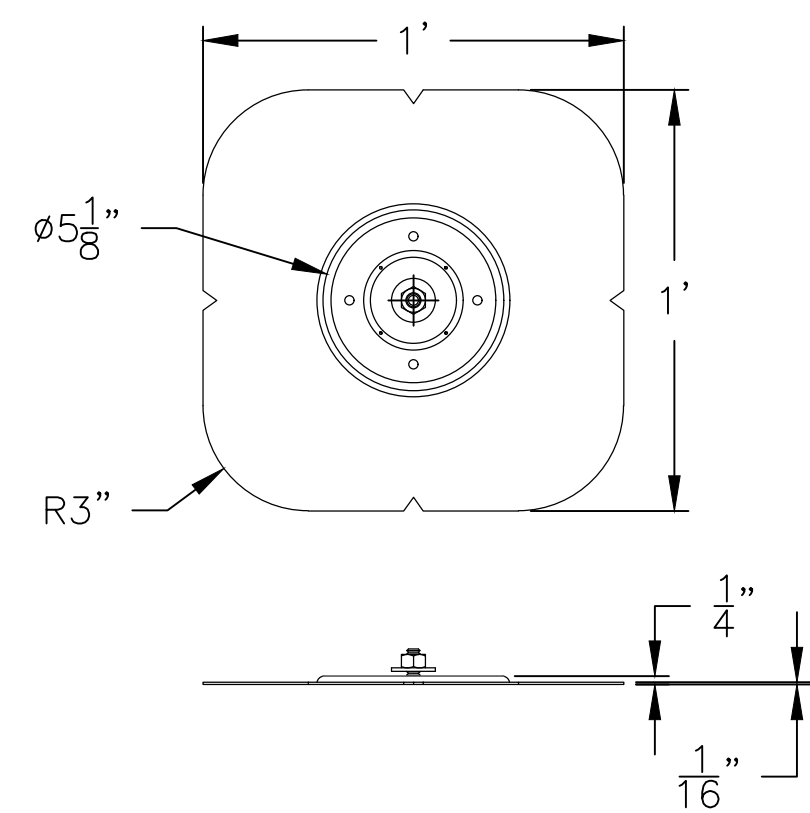

PROJECT INFO	Location	Location
	Installer	Installer
	Main Contact	Main Contact
	Email	Email
	Phone	Phone

DRAWING INFO.	
Date & Time	2/27/2017 12:27 PM
Prepared/Approved by	JC LR
Sheet Name	S3.0